

Varenummer: 03448340
Beskrivelse: Fluro Heavy Duty Ledleje GE 340 CW-2RS
Hul Ø340
Note: 340

Mål

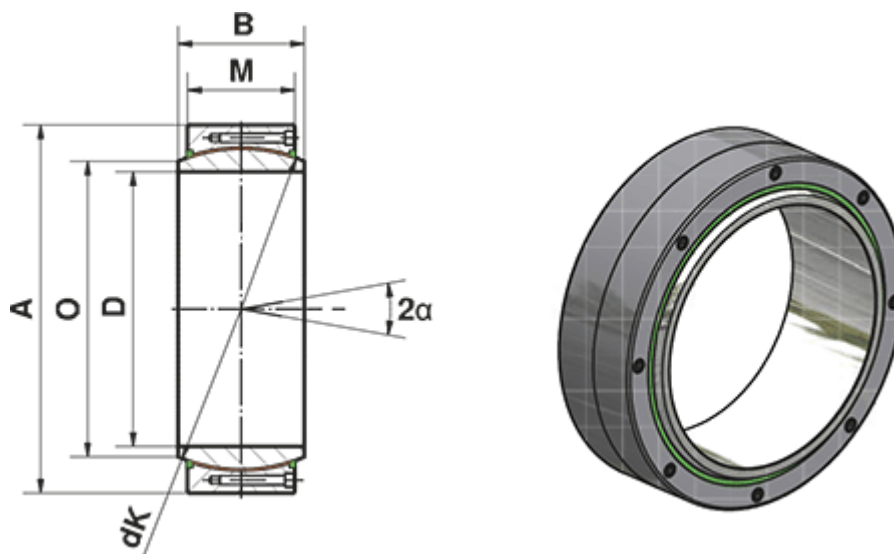

A	= 460
a (grader)	= 3.8
B	= 160
D	= 340
dK	= 400
Dynamisk belastning C (kN)	= 13530
M	= 135
O	= 366.6

Statisk belastning C0 (kN)	= 22550
Vægt (g)	= 80